

ML-20IP

IP video door station



Quick Installation Guide

SLINEX

{ Design. Uniqueness. Innovations }

Step 1

Angle bracket mount

- Take the angle bracket from the kit and place it 5 ft. up from the floor line.
- Mark and drill two holes in the wall.
- Take two wall anchors from the kit and hammer them into the drilled halls.
- Fix the angle bracket on the wall by the screws from the kit.
- Then fix surface mount bracket over the angle bracket by two bolts from the kit.

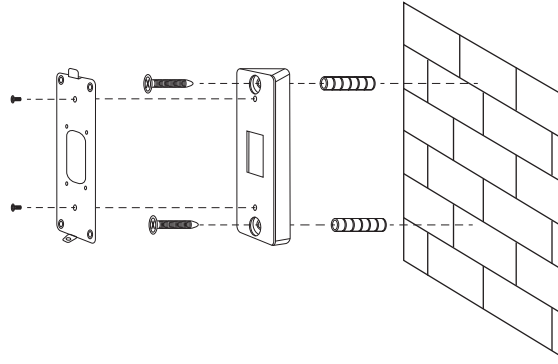

Surface mount

- Take the surface mount bracket from the kit and place it 5 ft. up from the floor line.
- Mark and drill four holes in the wall.
- Take four wall anchors from the kit and hammer them into the drilled holes.
- Fix surface mount bracket on the wall by four screws from the kit.

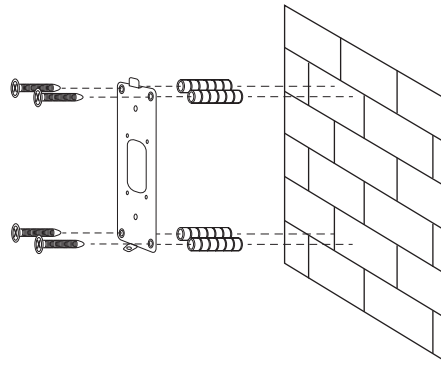

Step 2

Network connection

There are two ways of network connection possible: wired or wireless Wi-Fi connection.

In case of using wired network, see page 8 of the user manual.

In case of using wireless Wi-Fi network, connect external antenna from the kit to the SMA antenna plug on ML-20IP outdoor panel.



Wi-Fi antenna



SMA plug

Step 3

Connect 12V power adapter from the kit to the black wire (-) and red-white (+) wire of the outdoor panel (any of two black wires can be used). Isolate the wires by the tape to avoid short circuit problem. Note that (+) wire from the adapter has grey strips on the side.

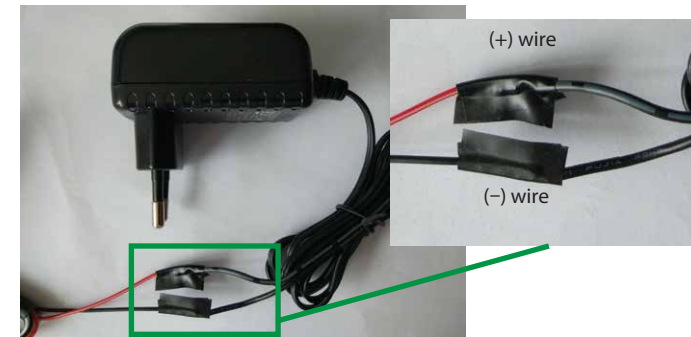

Step 4

ML-20IP can also manage lock and can be connected directly to any analog 4-wire monitor. Connection schematics displayed on the next diagram:

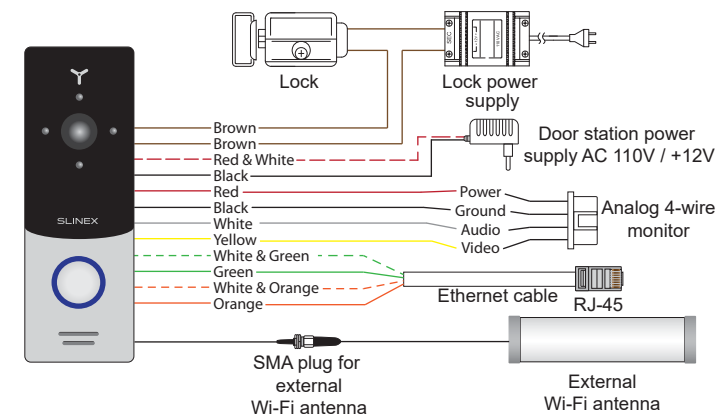

Step 5

After all connections have been made fix the door panel on the surface mount bracket by one bolt from the bottom side. Then connect power adapter to 110V AC power socket to start the system. Panel will emit sound signal after boot up.

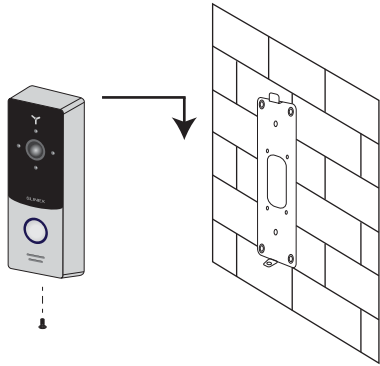

Step 6

Wireless network setup

- 1) Enter «GooglePlay» (for Android) or «AppStore» (for iOS) and search for «Slinex» application, then install this application on your mobile device.
- 2) Turn off mobile internet on your smartphone while installation process.
- 3) Run «Slinex» application on your mobile device and push  icon to add a new device.
- 4) Push «Click here for NEW wireless device» button on the mobile device
- 5) On the outdoor panel enter into «Access point» mode following next steps: press&hold call button → first short «beep» sound → release call button and quickly press&hold it again → second short «beep» sound → release call button and quickly press&hold it again → third double «beep» → release call button → door station will be restarted and then after a minute you will hear constant «beeps» sound. It means the door station entered «Access point» mode. Press «NEXT» button on the mobile device screen to go to the next step.
- 6) Wait for a minute while the door station connects your mobile device. On the Android devices the connection should be established automatically. If connection haven't been established then go to the smartphone Wi-Fi settings and connect IPdoor network manually.
On the iOS device user should connect to the outdoor station manually. Press «Wi-Fi settings» on the iOS device to view networks list. Look for IPdoor network of the door station and connect it. Then press «NEXT» button.
- 7) The list of the available wireless networks will be displayed in the next window. Choose the network which is the outdoor station will be connected and enter the password if it is needed. After that, the door station will be restarted and after a minute it will be connected to the chosen network.

8) Fill in the device information:











- Name: enter any device name you like in here
- UID: unique identification number of the device
- User: **Admin** (by default)
- Password: **888888** (by default)

then push «Confirm» button.

9) Device will be added to the bar in the middle part of the screen. You can also push alarm notification on or off by the blue switch in the devices list («Switch ON/OFF notification»).

Step 5







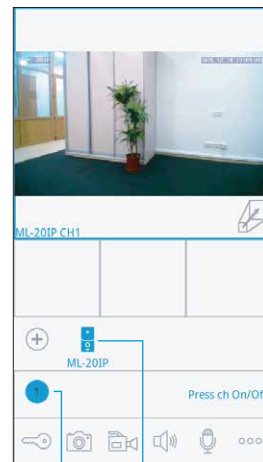







Operation

- to view the image from the outdoor station press device name  icon on the bar and then press channel number  icon to start monitoring mode.
- to stop monitoring mode press channel number icon  while monitoring.
- to start talk with the visitor while incoming call or viewing press  icon on the bottom bar, then press  icon.
- to end talk with the visitor press  icon on the bottom bar, then press channel number  icon to disable video streaming.
- to open the lock press  icon on the bottom bar then enter unlock password (default unlock password is 888888).
- to turn on sound from the the outdoor station while monitoring press  icon. To disable sound from the outdoor station press  icon again.

Mobile application menu





Channel number Device name

-  – add new device
-  – door unlock
-  – snapshot
-  – start/stop video recording
-  – turn on the sound from the door station
-  – press again to turn off the sound
-  +  – start conversation
-  – press again to stop conversation
-  – additional settings
-  – devices list
-  – local snapshots and video
-  – remote snapshots and video
-  – settings
-  – help

Incoming call notifications

Check both mobile device and door station are connected to the Internet.

Start «Slinex» application on the mobile device and press  icon on the bar to display additional settings menu. Then press  icon to enter device list.

On the right side from the device name you will see the switch. If it has blue color then alarm notification is enabled. If it has gray color then alarm notification is disabled.

While alarm notification is enabled the user will receive the alarm message if somebody presses the call button on the door station. Press «View» button to talk to the visitor or «Cancel» button to stop alarm message.

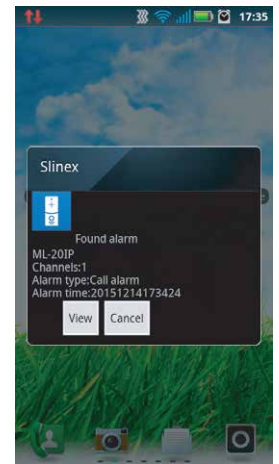
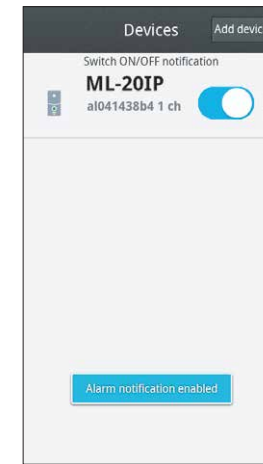

Note: For the iOS mobile devices, go to «Settings» → «Notifications», then click «Slinex» icon and make sure that all the notification are turned on:

Allow notifications;

Show in Notification Center;

Sounds;

Badge App Icon;

Show on Lock Screen.

