

SQ-07MT

7" indoor monitor with touch screen

video outdoor panel

ML-15HR



KIT

Quick Installation Guide

SLINEX

{ Design. Uniqueness. Innovations }

Step 1

- Take the indoor monitor surface mount bracket and place it 5 ft. up the floor line.
- Mark and drill four holes in the wall.
- Take four wall anchors from the kit and hammer them into the drilled holes.
- Fix surface mount bracket on the wall by four screws from the kit.

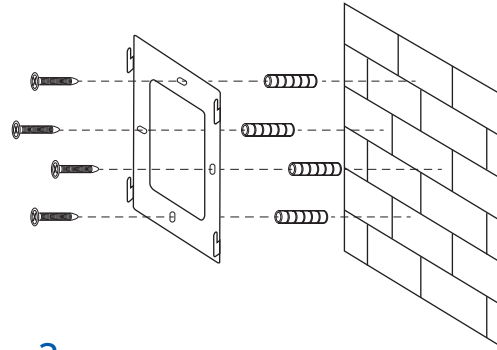

Step 2

- Take the outdoor panel angle bracket and place it 5 ft. up the floor line.
- Mark and drill two holes inside the wall;
- Take two wall anchors from the kit and hammer them into the drilled holes;
- Fix angle bracket on the wall by two screws from the kit;
- Fix wall mounting bracket on the angle bracket by two screws from the kit;

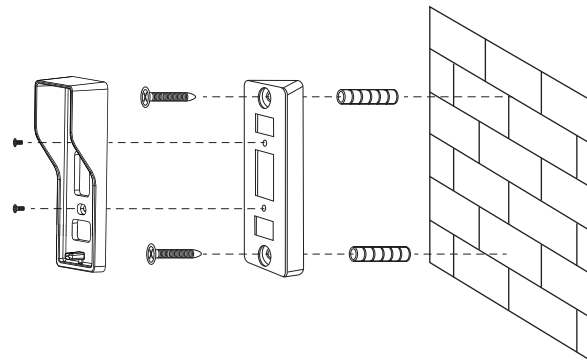

Step 3

Connect outdoor panel to indoor monitor by 4-wire AWG21 cable according to the wiring diagram on the next page.

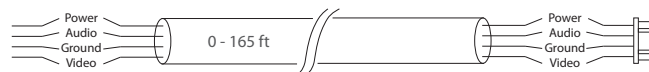

Wiring Diagram

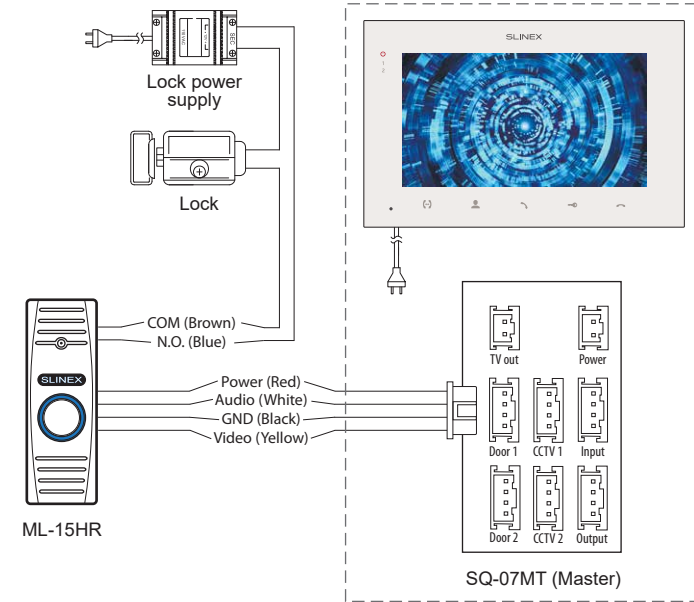

Step 4

- After all communication wires connection, fix indoor monitor and outdoor panel on the surface mount brackets installed previously.

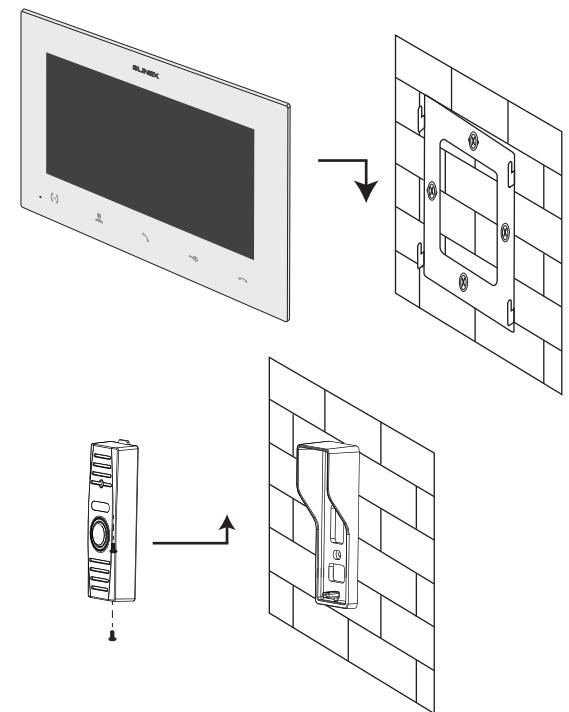

Step 5

Connect power plug of the indoor monitor to 110V AC power socket to start the system. Monitor will emit sound signal after boot up.

Operation

Keyboard operation

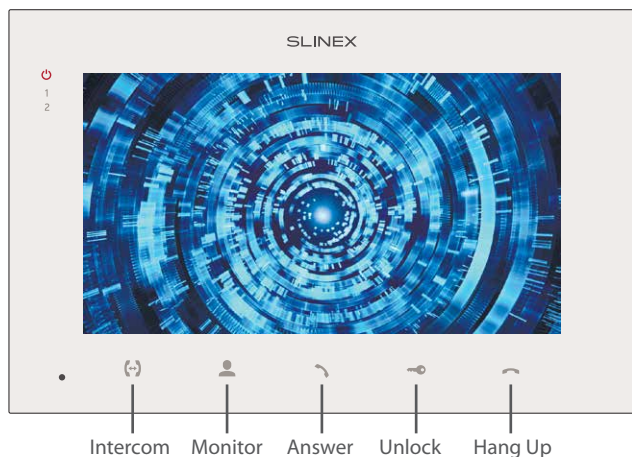

Intercom – call another monitor or incoming call redirection;

Monitor – door panel or camera image monitoring;

Answer – incoming call answer and start talking with the visitor;

Unlock – door unlocking while conversation or monitoring;

Hang Up – stop conversation with the visitor / current system settings menu exit.

Touch screen operation

 In standby mode touch any part of the screen to activate main menu.

 Then touch any icon to enter current sub menu.

 While incoming call or monitoring slide from up to bottom side of the screen to start conversation with the visitor.

 While conversation or monitoring slide from bottom to up side of the screen to open lock connected to the outdoor panel.



 Slide two fingers towards each other to stop conversation, incoming call or monitoring.

 In standby mode slide from left to right side of the screen to start outdoor panel monitoring.

Incoming call

Press «Call» button on the outdoor panel. The indoor monitor will start ringing.

Press  button on the indoor monitor to start conversation with the visitor. Talking time is 120 seconds.

Press  button on the indoor monitor to open lock for a visitor or  button to stop conversation with the visitor and go into standby mode.

Monitor will be automatically switched into standby mode if the user doesn't answer incoming call during 60 seconds.

Monitoring

In standby mode press  button on the indoor monitor to start outdoor panel image monitoring.

Press  button to stop image monitoring and go into standby mode.

Main menu

In standby mode press any part of the screen to activate main menu.

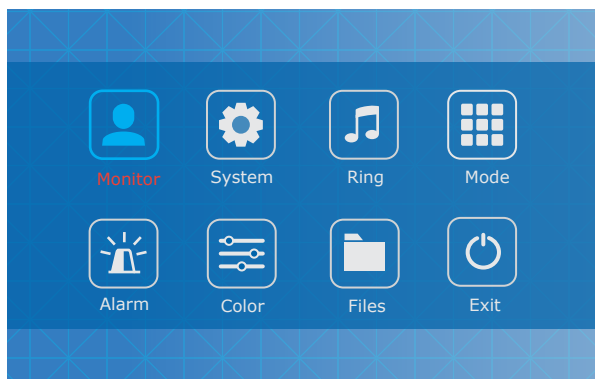

Following sub menus are available in the main menu:

Monitor – choose the channel to start monitoring;

System – language, date and time, memory format and software upgrade settings;

Ring – volume and incoming call melody selection;



Mode – indoor monitor address, second outdoor panel activation, record mode, unlock time, outdoor panel backlight and keyboard sound settings.

Alarm – hardware and software alarm sensors settings;

Color – image brightness, contrast and color settings;

Files – snapshots and records playback;

Recording

User can take snapshots or record video during conversation or monitoring outdoor panel. Press  icon on the screen to take snapshot or press  icon on the screen to start video recording. Press the same icon second time to stop video recording.

Depending on the «Record mode» setting monitor will be automatically taking snapshots or recording video while incoming call from the outdoor panel.

Note:

Video can be recorded only if microSD card installed into monitor slot. If microSD is absent then monitor can only record snapshots using internal memory, no matter what «Record mode» has been set.

100 snapshots can be stored in the internal memory. If the quantity exceeds 100 snapshots then older snapshots will be replaced by new one.

Records playback

Press «Files» icon in the monitor's main menu to enter snapshots and records playback. Following parameters are available in the «Files» menu:

Record files – video playback;

Snapshot files – snapshots playback.

Select «Record files» or «Snapshot files» icon, then press file name to start playing. While playing press  button to go back to the files list.

If you want to delete the file, press and hold the finger for two seconds on selected file name. File context menu will appear on the screen. Select one of three options:

Play – current file playing;

Delete current file – current file deleting;

Delete all files – all files deleting

or press  button to close context menu.

